



















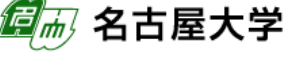

Ja Sakai 2013 Activity & 2014 Plan

March 10, 2014

Ja Sakai Steering Committee

Sakai/Ja Sakai Community History



2003	2004	2005	2006	2007	2008	2009	2010	2011	2012	2013	2014	2015
<p>Sakai</p> <p>Sakai/Apereero Conference</p> <p>Ja Sakai Conference</p> <p>Membership</p>												
	★ ★ ★ ★ ★ ★ ★ ★				★	★	★	★	★	★	★	★
					 <p>1-3 JULY 2008 PARIS, FRANCE</p>	 <p>Boston, MA - July 8-10, 2009</p>	 <p>DENVER 2010</p>	 <p>Sakai Los Angeles Open Opportunities Endless Possibilities 2011</p>	 <p>apereero</p>  <p>Jasig Sakai ATLANTA • 2012</p>		 <p>Miami (Jun 1- 4)</p>	
					★	★	★	★	★	★	★	★
	 <p>名古屋大学</p>  <p>法政大学 HOSEI University</p>				★	★	★	★	★	★	★	★
					法政大学	名古屋大学	熊本大学	関西/大阪	法政大学	京都大学	名古屋大学	
						 <p>大阪大学 OSAKA UNIVERSITY</p>	 <p>THINK × ACT 関西大学</p>		 <p>京都大学 KYOTO UNIVERSITY</p>			
								 <p>KEL KANEMATSU ELECTRONICS LTD.</p>	 <p>NS Solutions</p>	 <p>asahi net international</p>		

Review - Activity 2013 (2013.4 – 2014.3)

Ja Sakai coordinates, harmonizes and unites the activities of each university.

1. Ja-Sakai Dev WG (Development and functional enhancement of a Japanese version of Sakai)

- ePortfolio - Karuta by Kyoto University 
- SaaS Sakai - KEL cloud service 
- Paper media integration with Sakai - Fuji Xerox/Hosei University  **NEW**
- Digital Paper integration with Sakai – Sony/Hosei University  **NEW**

2. i18n/l10n WG (Internationalization and Localization of Sakai outcome)

- Developing translation memory exchange for OSSs for higher education 
- Hosei University signed CCLA and CLA 





3. Ja-Sakai Conference WG (Coordination of Ja-Sakai Conference)

- Convened 7th Ja Sakai conference by Nagoya University 

4. Ja-Sakai Administration WG (Administration of Ja-Sakai Community)

- Maintain Ja Sakai Web site 
- Contacted Open Source Project Licensed JIRA/Confluence 

5. Ja-Sakai Advocacy WG (Deploy Sakai in Japan, Deploy Japan in Sakai)

- Presentation at the Open Apero Conference, San Diego 
- Presentation at AXIES (Japanese EDUCAUSE) and CLE SIG of IPSJ 
- Archiving Sakai related resources and papers in the Ja Sakai Web site 
- AXIES OSS WG – Sakai Sub WG 

THE NAME

Karuta (カルタ金) was a type of armour worn by samurai warriors and their retainers during the feudal era of Japan. The word karuta comes from the Portuguese word meaning "card", (carta) as the small square or rectangular plates that compose the armour resemble traditional Japanese playing cards.



<http://www.japanese-armor.com/Takeda-Shinten-Daiymo-Armor.html>

Development of common TMX to translate OSSs for Higher Education

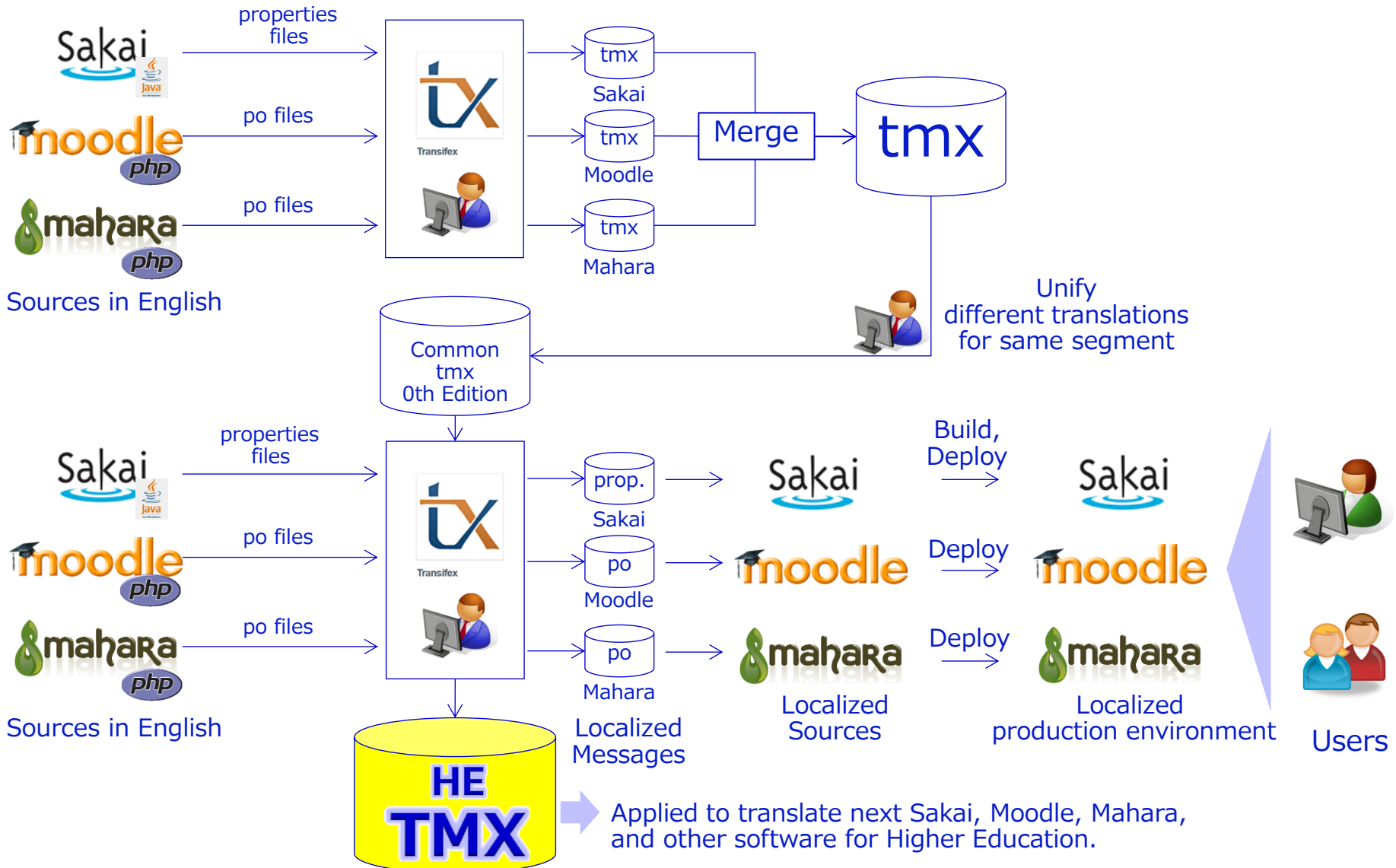
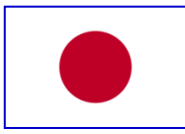

The screenshot shows a Sakai workspace for 'Hokusei University' with the title '2013 コンピュータサイエンス論'. The file list includes folders like 'mobile', 'life', 'learning', 'Web', and 'cs2013', and files like 'sample_template.pptx', '_TED', and 'WORDによるレポート作成参考資料'. A yellow callout box points to the 'learning' folder with the text 'Drop box for Report (Read Write)'. Another yellow callout box points to the 'cs2013' folder with the text 'Templates (Read Only)'.

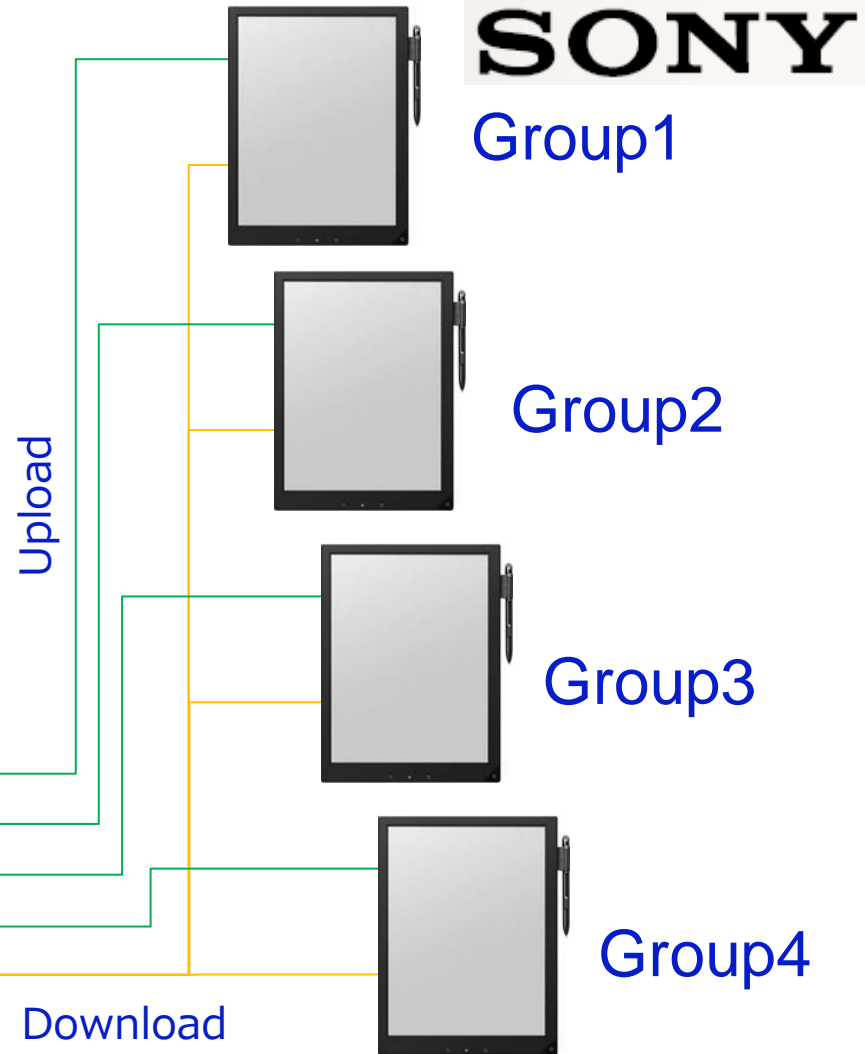

SONY

Group1

Group2

Group3

Group4

Upload

Download

Conferences 2013



(Jun. 3 - 6)



Unconference
at Kyoto University
(Aug 21, 22)



AXIES
(Dec. 19)

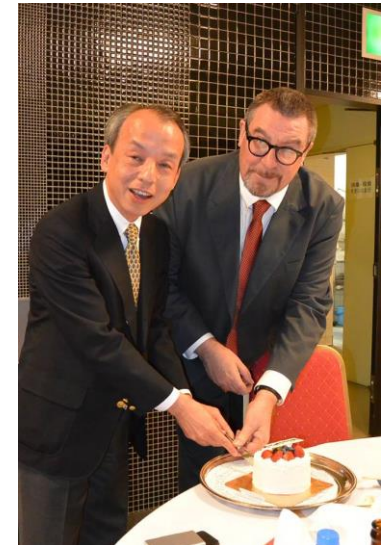

Plan 2014 (2014.4 – 2015.3)

Coordinate and integrate the contribution of each university as Ja Sakai activities.

1. Ja-Sakai Dev WG (Development and functional enhancement of a Japanese version of Sakai)
 - ePortfolio
 - Integration of new devices
 - MOOCs **NEW**

2. i18n/l10n WG (Internationalization and Localization of Sakai outcome)
 - Develop translation memory exchange for OSSs for higher education.

3. Ja-Sakai Conference WG (Coordination of Ja-Sakai Conference)
 - Convene 8th Ja Sakai conference

4. Ja-Sakai Administration WG (Administration of Ja-Sakai Community)
 - Maintain Ja Sakai Web site
 - Reconsider Ja Sakai bylaw and its naming **NEW**

5. Ja-Sakai Advocacy WG (Deploy Sakai in Japan, Deploy Japan in Sakai)
 - Presentation at the Open Apero Conference, Miami
 - Presentation at AXIES (Japanese EDUCAUSE) and CLE SIG of IPSJ
 - Archive Sakai related resources and papers in Web site
 - AXIES OSS WG – Sakai Sub WG



Sakai

+



Jasig

=



apereo

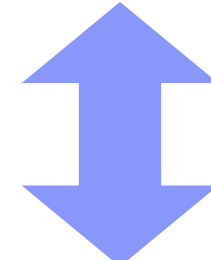

+

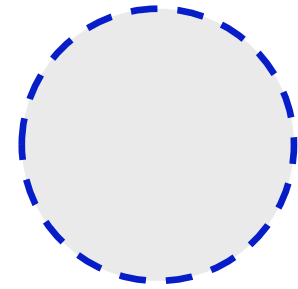

=

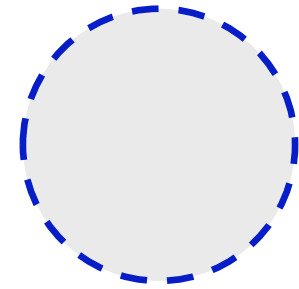

Ja Sakai

2014年度 代表, 副代表, 幹事

代表

常盤祐司(法政大学・情報メディア教育研究センター)

副代表

出口大輔(名古屋大学・情報連携統括本部情報戦略室)

近藤壮一(兼松エレクトロニクス株式会社)

幹事

上田真由美(流通科学大学・総合政策学部)

河邊俊一(新日鉄住金ソリューションズ株式会社)

竹川隆司(株式会社 朝日ネット)

竹村治雄(大阪大学・サイバーメディアセンター)

玉木久夫(明治大学・理工学部情報科学科)

平岡齊士(京都大学・学際融合教育研究推進センター)

冬木正彦(畿央大学・教育学部)

宮崎 誠(法政大学・情報メディア教育研究センター)

本村康哲(関西大学・文学部)

Apereo Foundation

梶田将司(京都大学・情報環境機構IT企画室)



Ja Sakaiger #2